

PKKW

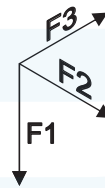

F1 = 1500N
F2 = 700N
F3 = 400N

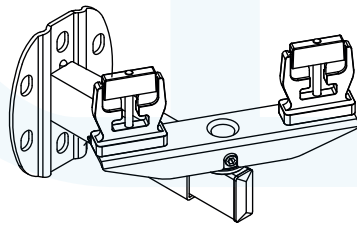
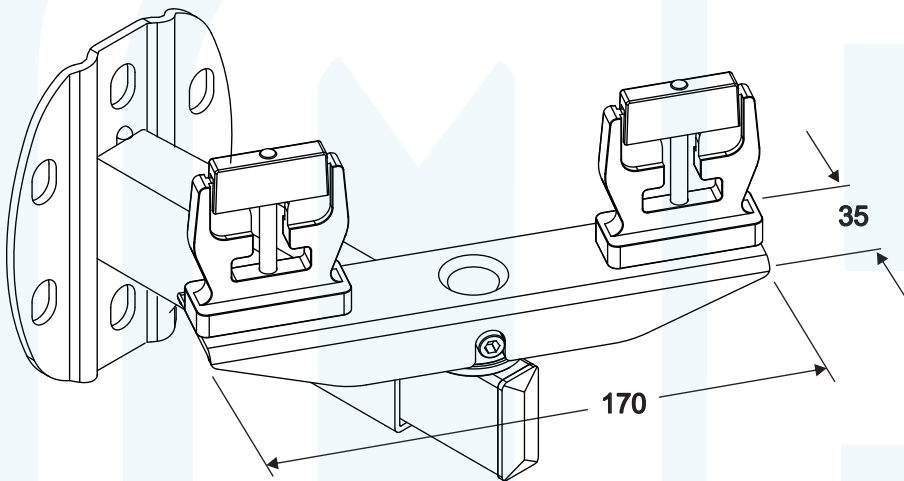
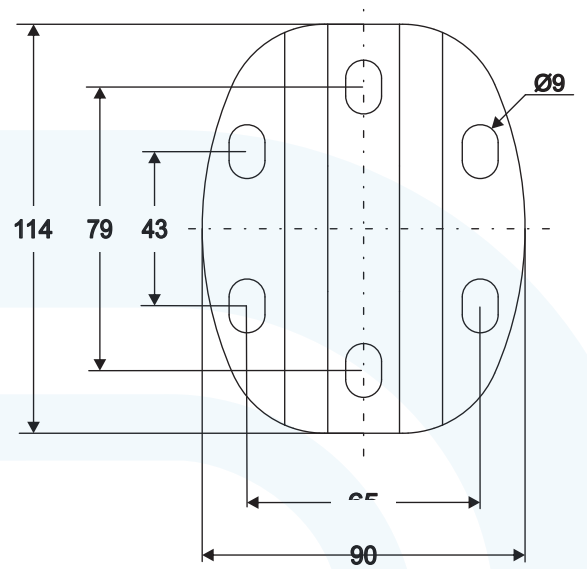
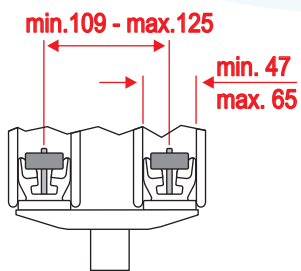

PKKW-1

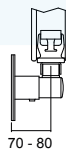

PKKW-2

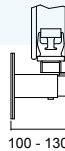

PKKW-3

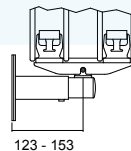

PKKW-4

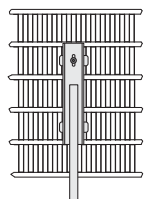
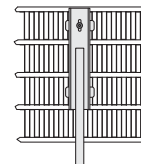
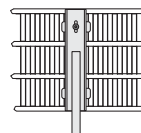
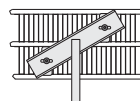
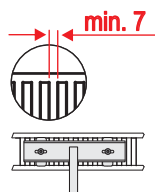
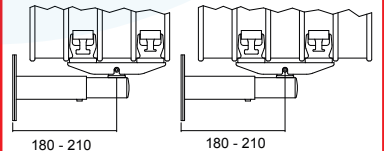

The stated load capacity refers to a single fastener under ideal test conditions.

The design and sizing of the fastening system, the load-bearing capacity of the installation substrate, and the radiator's compatibility are the responsibility of the engineer. The fastener manufacturer disclaims all liability for improper use or non-compliant installations.