

PX1

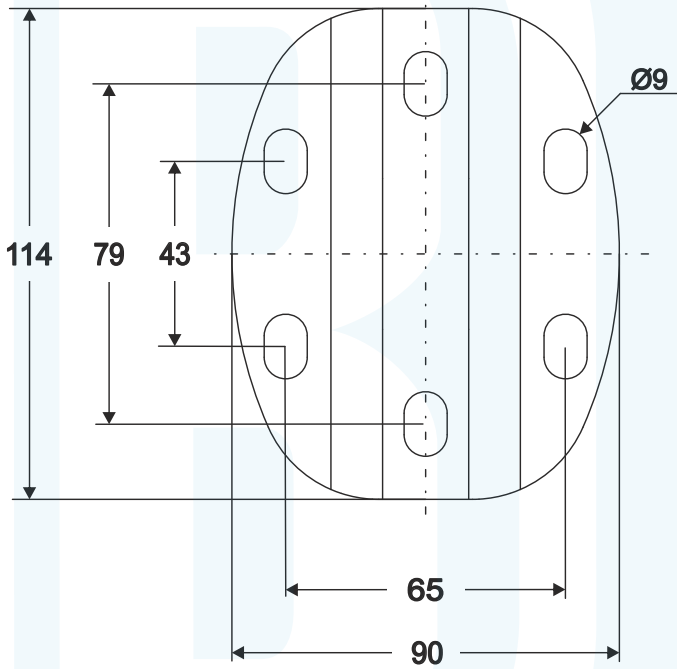

VA_MES 15 06 059

PATENTED

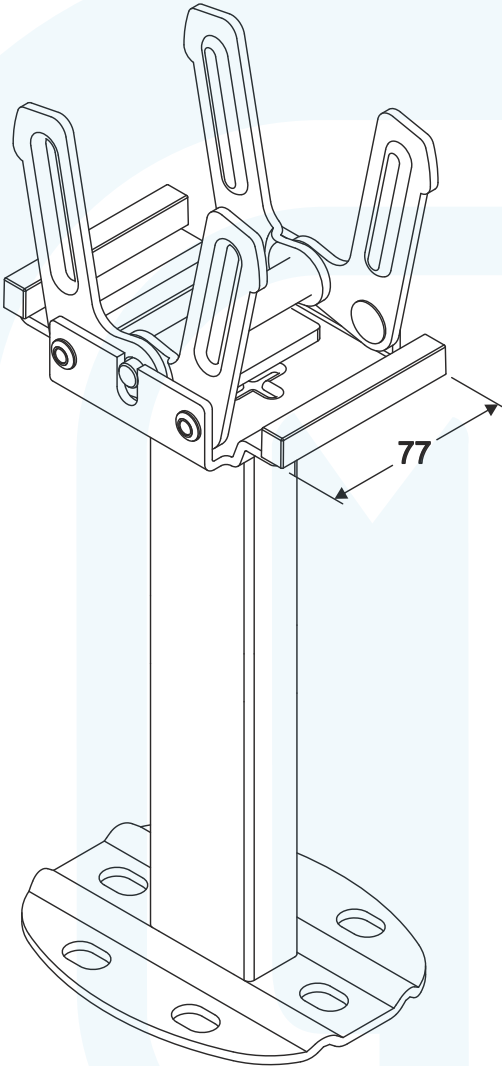

<p>Type 22 Type 33 Type 30</p>	<p>$F_1 = 2000N$ $F_2 = 700N$ $F_3 = 400N$</p>	<p>max 1000</p> <p>min.240 max.315</p>
<p>91 - 92</p>	<p>89 - 90</p>	<p>86 - 88</p>

The stated load capacity refers to a single fastener under ideal test conditions. The design and sizing of the fastening system, the load-bearing capacity of the installation substrate, and the radiator's compatibility are the responsibility of the engineer. The fastener manufacturer disclaims all liability for improper use or non-compliant installations.